



1-800-SAMSUNG(1-800-726-7864)

U.S.A
Samsung Electronics America
Service Division
400 Valley Road, Suite 201
Mount Arlington, NJ 07856

www.samsungusa.com

Canada
Samsung Electronics Canada Inc.
Samsung Customer Care
7037 Financial Drive
Mississauga, Ontario
L5N 6R3

www.samsung.ca

BN68-00633A-01

SAMSUNG

LT-P 1545
LT-P 1745
LT-P 2045

TFT-LCD TELEVISION



Owner's Instructions

This device is a Class B digital apparatus.

CONTENTS

Chapter 1: Your New TV

List of Features	1
List of Parts	1
Familiarizing Yourself with Your New TV	2
Top Panel Buttons	2
Rear Panel Jacks	3
Remote Control	4
Installing Batteries in the Remote Control	5
If remote control doesn't work!	5

Chapter 2: Installation

Connecting VHF and UHF Antennas	6
Antennas with 300-ohm Flat Twin Leads	6
Antennas with 75-ohm Round Leads	7
Separate VHF and UHF Antennas	7
Connecting Cable TV	7
Cable without a Cable Box	7
Connecting to a Cable Box that Descrambles All Channels ...	8
Connecting to a Cable Box that Descrambles Some Channels ...	8
Connecting a VCR	10
Connecting an S-VHS VCR	11
Connecting a DVD Player	12

Chapter 3: Special Features

Turning the TV On and Off	13
Changing Channels	13
Using the Channel Buttons	13
Using the Pre-CH Button to select the Previous Channel ...	13
Adjusting the Volume	13
Using Mute	13
Viewing the Display	14
Viewing the Menus	14

Chapter 4: Operation

Plug & Play Feature	15
Memorizing the Channels	16
Selecting the Video Signal-source	16
Storing Channels in Memory (Automatic Method)	17
To check the channels stored in memory	17
To select channels over 100	17
ADD and DEL Channels (Manual Method)	18
To select the Input Source	19
To Edit the Input Source Name	20
Using Automatic Picture Settings	21
Customizing the Picture	22

CONTENTS

Using Automatic Sound Settings 23
 To select the Sound option 24
 Selecting a Menu Language 25
 Setting the Blue Screen Mode 26
 Adjusting the Color Tone 27
 Automatic Volume Control 28
 Setting the Clock 29
 Option 1: Setting the Clock Manually 29
 Option 2: Using the Local PBS Channel to Automatically
 Set the TV Clock 30
 Setting the On/Off Timer 32
 Setting the Sleep Timer 34
 Viewing Closed Captions 35
 Using the V-Chip 36
 Setting Up Your Personal ID Number (PIN) 36
 How to Enable/Disable the V-Chip 37
 How to Set up Restrictions Using the ‘TV guidelines’ 38
 How to Set up Restrictions Using the MPAA Ratings:
 G, PG, PG-13, R, NC-17, X 40
 How to Reset the TV after the V-Chip
 Blocks a Channel (‘Emergency Escape’) 41

Chapter 5: PC Display

Using Your TV as a Computer (PC) Display 42
 How to Set up Your PC Software (Windows only) 42
 Adjusting the Screen Quality 43
 Changing the Screen Position 44
 To Initialize the Screen Position or Color Settings 45
 How to Auto Adjust 46
 Using Automatic Picture Settings 47
 Customizing the Picture 48
 Adjusting the Color Tone 49
 Customizing the color 50

Appendix

Using the Anti-Theft Kensington Lock 51
 Retractable Stand 51
 Installing the Wall Mount Kit (sold separately) 52
 Installing VESA compliant mounting devices 53
 Cleaning and Maintaining Your TV 54
 Using Your TV in Another Country 54
 Display Mode 55
 Specifications 56

Chapter One

YOUR NEW TV

List of Features

Your TV was designed with the latest technology.

This TV is a high-performance unit that includes the following special features:

- Easy-to-use remote control
- Easy-to-use on-screen menu system
- Automatic timer to turn the TV on and off
- Adjustable picture and sound settings that can be stored in the TV's memory
- Automatic channel tuning for up to 193 channels.(Air : 69 , STD : 124)
- A special filter to reduce or eliminate reception problems
- Fine tuning control for the sharpest picture possible
- A built-in multi-channel sound decoder for stereo and bilingual listening
- Built-in, dual channel speakers
- Headphone jack for private listening

List of Parts

Please make sure the following items are included with your LCD TV.

If any items are missing, contact your dealer.

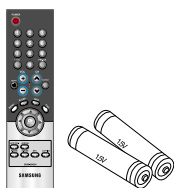

Remote Control
(BN59-00429A) &
Batteries (AAA x 2)

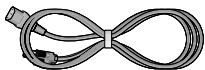

Power Cord
BH39-10339X

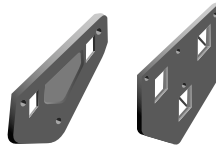

15" / 17"

20"

Wall Mount kit
15"/17" : BN96-01270A
20" : BN96-01271A

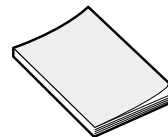

Owner's
Instructions

YOUR NEW TV

Familiarizing Yourself with Your New TV

Front Panel Buttons

The buttons on the front panel control your TV's basic features, including the on-screen menu. To use the more advanced features, you must use the remote control.

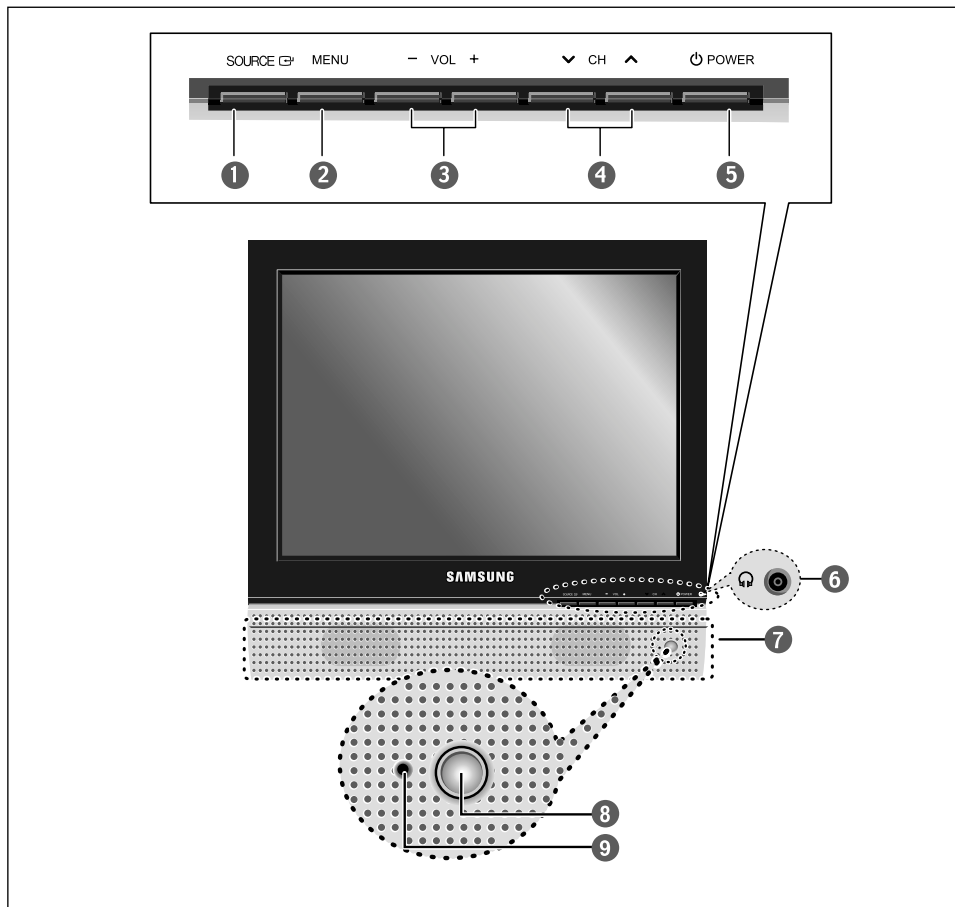

1 SOURCE

Displays a menu of all of the available input sources (TV, VIDEO, S-VIDEO, Component, PC).

- ▶ You can also use the TV/Video() buttons on the TV's control panel to make selections.

2 MENU

Press to see an on-screen menu of your TV's features.

3 - VOL +

Press to increase or decrease the volume
Press to see an on-screen menu on the screen.

4 CH

Press to change channels. Also press to highlight various items on the on-screen menu.

5 POWER

Press to turn the TV on and off.

6 HEADPHONE JACK

Connect a set of external headphones to this jack for private listening.

7 SPEAKERS

8 REMOTE CONTROL SENSOR

Aim the remote control towards this spot on the TV.

9 POWER INDICATOR

Lights up when you turn the power off.

YOUR NEW TV

Rear Panel Jacks

Use the rear panel jacks to connect an A/V component that will be connected continuously, such as a VCR or a DVD player.

For more information on connecting equipment, see pages 6~12.

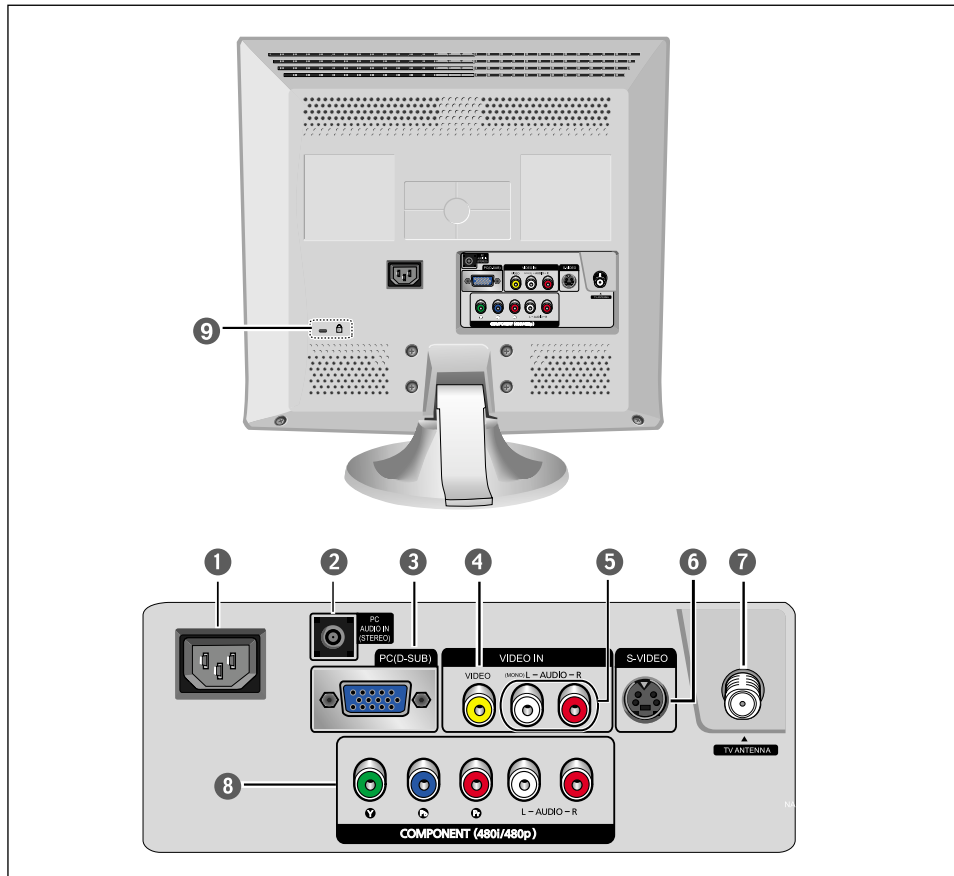

1 POWER INPUT

2 PC AUDIO IN (STEREO)

3 PC VIDEO INPUT

Connect to the video output port on your PC.

4 VIDEO INPUT

Connect a video signal from a camcorder or VCR.

5 AUDIO INPUT

Connect an audio signal(L/R) from a camcorder or VCR.

6 S-VIDEO INPUT

Connect an S-Video signal from a camcorder or VCR.

7 TV ANTENNA

Connect to an antenna or to a cable TV system.

8 COMPONENT

Connect a component video/audio.

9 KENSINGTON LOCK

(See page 51)

YOUR NEW TV

Remote Control

You can use the remote control up to a distance of about 23 feet from the TV.
When using the remote, always point it directly at the TV.

- 1 POWER** (See Page 13)
Turns the TV on and off.

- 2 NUMBER BUTTONS**
Press to select channels directly on the TV.

- 3 +100**
Press to select channels over 100.
For example, to select channel 121, press "+100," then press "2" and "1."

- 4 CH \wedge and \vee CH (Channel Up/Down)**
Press CH \wedge or CH \vee to change channels.

VOL+ and VOL-
Press to increase or decrease the volume.

- 5 MUTE** (See Page 13)
Press to temporarily cut off the sound.

- 6 SLEEP** (See Page 34)
Press to select a time for the TV to turn off automatically.

- 7 MENU**
Displays the main on-screen menu.

- 8 UP/DOWN/LEFT/RIGHT/ENTER**
Use to select on-screen menu items and change menu values.
(The remote control will only function with VCR or DVD units that are compatible with the LCD TV.)

- 9 AUTO PROG.**
Use to store the broadcast/cable channels that you receive.

- 10 P.MODE**
Adjust the TV picture by selecting one of the preset factory settings.

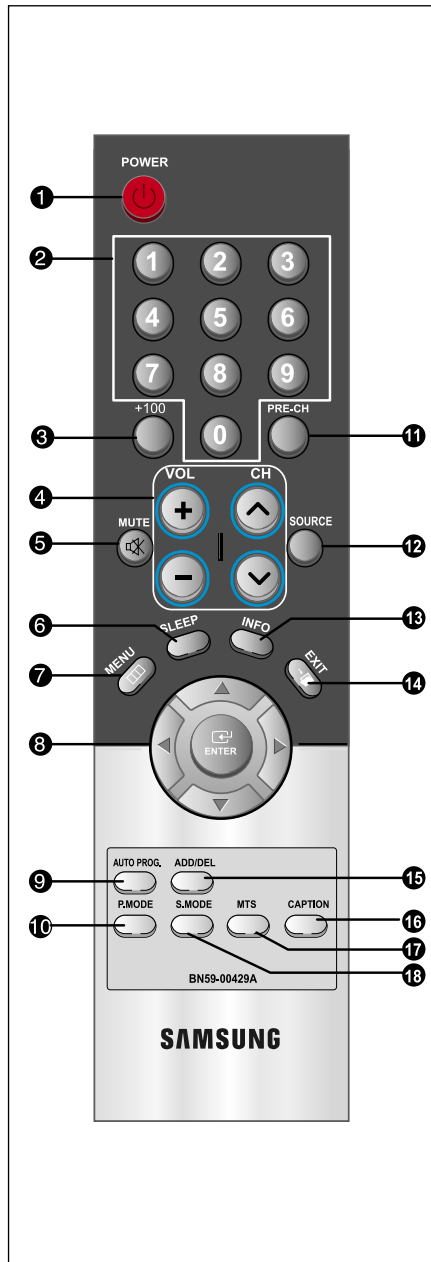

- 11 PRE-CH**
Tunes to the previous channel.

- 12 SOURCE**
Input source selection

- 13 INFO DISPLAY**
Use to see information on the current broadcast.

- 14 EXIT** 
Press the menu to exit.

- 15 ADD/DEL**
Use to store and delete channels to/from memory.

- 16 CAPTION**
Press to set caption on/off.

- 17 MTS (Multichannel Television Stereo)**
Press to choose stereo, mono or Separate Audio Program (SAP broadcast).

- 18 S.MODE**
Regule o som do televisor seleccionando uma das definições de fábrica

YOUR NEW TV

Installing Batteries in the Remote Control

1

Slide the cover out completely.

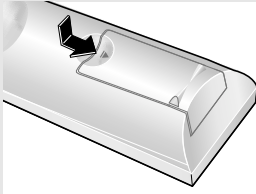
**2**

Install two AAA size batteries.

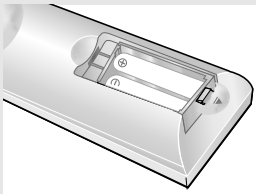

◀ Make sure to match the “+” and “-” ends of the batteries with the diagram inside the compartment.

3

Replace the cover.

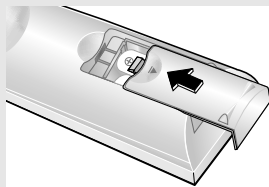

◀ Remove the batteries and store them in a cool, dry place if you won't be using the remote control for a long time.

The remote control can be used up to about 23 feet from the TV.

(Assuming typical TV usage, the batteries last for about one year.)

If remote control doesn't work

Check the following:

1. Is the TV power switch on?
2. Are the plus and minus ends of the batteries reversed?
3. Did the batteries run out?
4. Is the power out, or is the power cord unplugged?
5. Is there a special fluorescent light or a neon sign nearby?

Chapter Two

INSTALLATION

Connecting VHF and UHF Antennas

If your antenna has a set of leads that look like this, see “Antennas with 300-ohm Flat Twin Leads” below.



If your antenna has one lead that looks like this, see “Antennas with 75-ohm Round Leads” on page 7.



If you have two antennas, see “Separate VHF and UHF Antennas” on page 7.

Antennas with 300-ohm Flat Twin Leads

If you are using an off-air antenna (such as a roof antenna or “rabbit ears”) that has 300-ohm twin flat leads, follow the directions below.

1

Place the wires from the twin leads under the screws on a 300-75 ohm adaptor (not supplied). Use a screwdriver to tighten the screws.

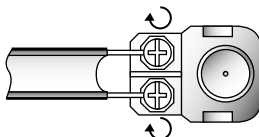

2

Plug the adaptor into the TV ANTENNA terminal on the bottom of the back panel.

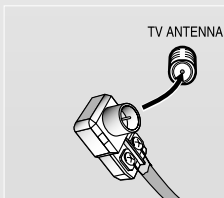

INSTALLATION

Antennas with 75-ohm Round Leads

1

Plug the antenna lead into the TV ANTENNA terminal on the bottom of the back panel.

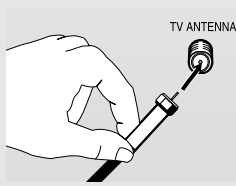

Separate VHF and UHF Antennas

If you have two separate antennas for your TV (one VHF and one UHF), you must combine the two antenna signals before connecting the antennas to the TV. This procedure requires a an optional combiner-adaptor (available at most electronics shops).

1

Connect both antenna leads to the combiner.

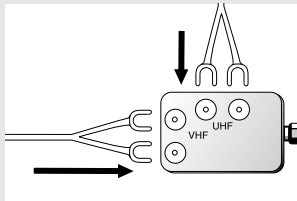

2

Plug the combiner into the TV ANTENNA terminal on the bottom of the rear panel.

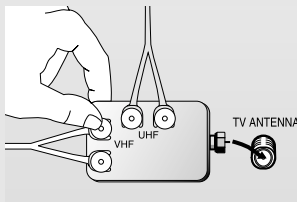

Connecting Cable TV

To connect to a cable TV system, follow the instructions below.

Cable without a Cable Box

1

Plug the incoming cable into the TV ANTENNA terminal on back of the TV.

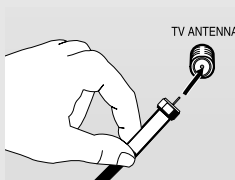

◀ Because this TV is cable-ready, you do not need a cable box to view unscrambled cable channels.

INSTALLATION

Connecting to a Cable Box that Descrambles All Channels

1

Find the cable that is connected to the ANTENNA OUT terminal on your cable box.

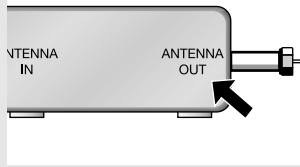

◀ This terminal might be labeled “ANT OUT”, “VHF OUT”, or simply, “OUT”.

2

Connect the other end of this cable to the TV ANTENNA terminal on the back of the TV.

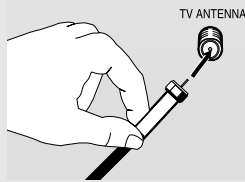

Connecting to a Cable Box that Descrambles Some Channels

If your cable box descrambles only some channels (such as premium channels), follow the instructions below. You will need a two-way splitter, an RF (A/B) switch, and four lengths of coaxial cable. (These items are available at most electronics stores.)

1

Find and disconnect the cable that is connected to the ANTENNA IN terminal on your cable box.

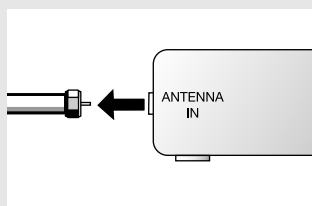

◀ This terminal might be labeled “ANT IN”, “VHF IN”, or simply, “IN”.

2

Connect this cable to a two-way splitter.

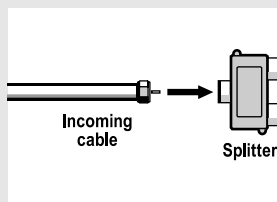

3

Connect a coaxial cable between an OUTPUT terminal on the splitter and the IN terminal on the cable box.

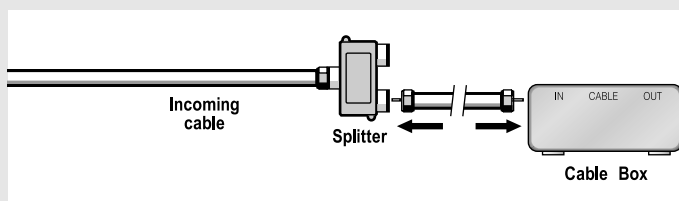

INSTALLATION

4

Connect a coaxial cable between the ANTENNA OUT terminal on the cable box and the B-IN terminal on the A/B switch.

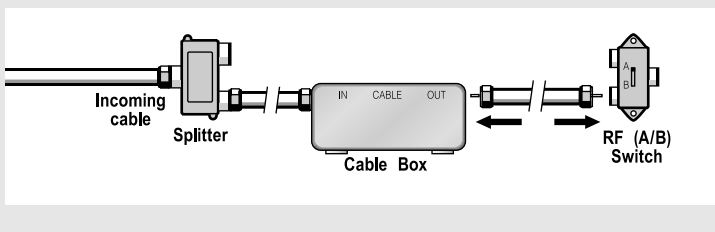

5

Connect another cable between the other OUT terminal on the splitter and the A-IN terminal on the RF (A/B) switch.

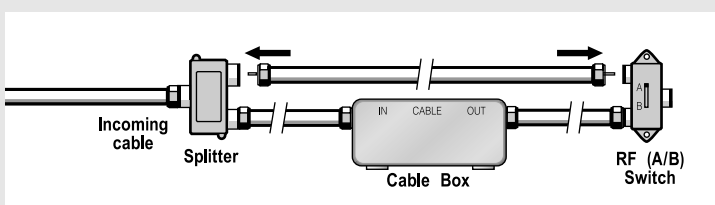

6

Connect the last coaxial cable between the OUT terminal on the RF (A/B) switch and the VHF/UHF terminal on the rear of the TV.

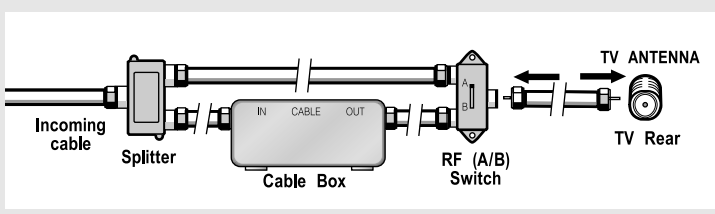

After you've made this connection, set the A/B switch to the "A" position for normal viewing. Set the A/B switch to the "B" position to view scrambled channels. (When you set the A/B switch to "B," you will need to tune your TV to the cable box's output channel, which is usually channel 3 or 4.)

INSTALLATION

Connecting a VCR

These instructions assume that you have already connected your TV to an antenna or a cable TV system (according to the instructions on pages 6-9). Skip step 1 if you have not yet connected to an antenna or a cable system.

1

Unplug the cable or antenna from the back of the TV.

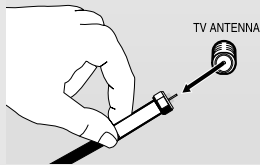

2

Connect the cable or antenna to the ANTENNA IN terminal on the back of the VCR.

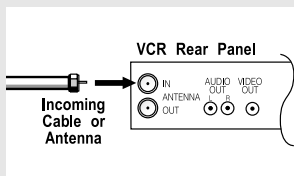

3

Connect a coaxial cable between the ANTENNA OUT terminal on the VCR and the antenna terminal on the TV.

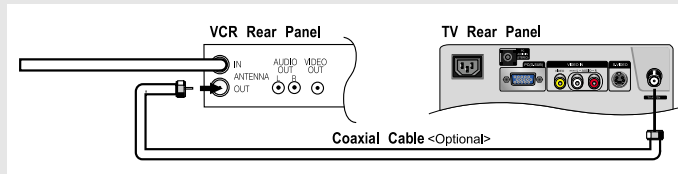

A coaxial cable is usually included with a VCR. (If not, check your local electronics store).

4

Connect a set of audio cables between the AUDIO OUT jacks on the VCR and the AUDIO jacks on the TV.

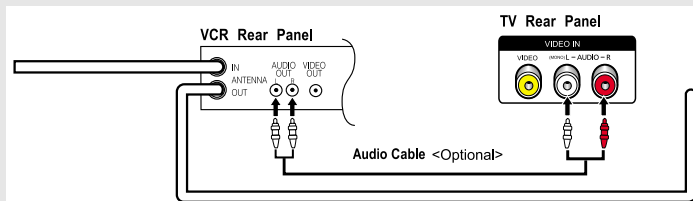

If you have a “mono” (non-stereo) VCR, use the Y-connector (not supplied) to hook up to the left and right audio input jacks of the TV.
If your VCR is stereo, you must connect two cables.

5

Connect a video cable between the VIDEO OUT jack on the VCR and the VIDEO jack on the TV.

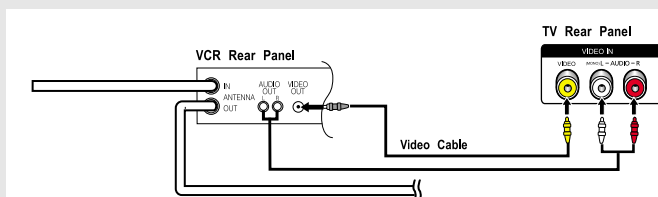

Follow the instructions in “Viewing a VCR or Camcorder Tape” to view your VCR tape.

* Each external input source device has a different back panel configuration.

INSTALLATION

Connecting an S-VHS VCR

Your Samsung TV can be connected to an S-Video signal from an S-VHS VCR.
(This connection delivers a better picture as compared to a standard VHS VCR.)

1

To begin, follow steps 1–3 in the previous section to connect the antenna or cable to your VCR and your TV.

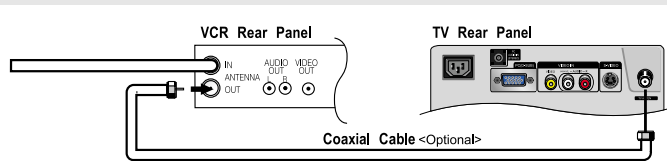

2

Connect a set of audio cables between the AUDIO OUT jacks on the VCR and the AUDIO INPUT jacks on the TV.

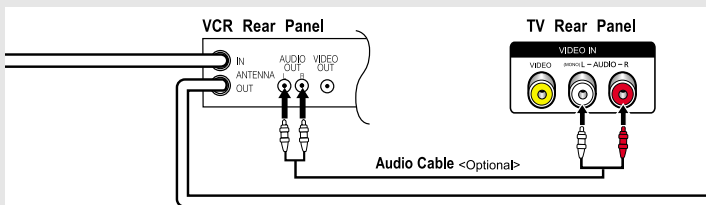

3

Connect an S-video cable between the S-VIDEO OUT jack on the VCR and the S-VIDEO INPUT jack on the TV.

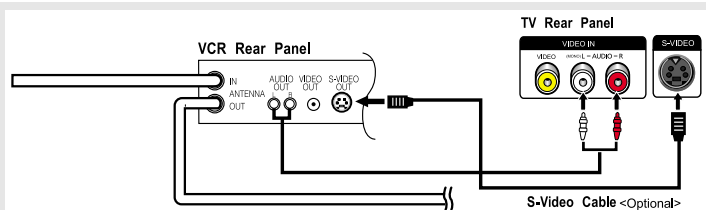

An S-video cable is usually included with an S-VHS VCR.

(If not, check your local electronics store.)

* Each external input source device has a different back panel configuration.

INSTALLATION

Connecting a DVD Player

The rear panel jacks on your TV make it easy to connect a DVD player to your TV.

1

Connect a set of audio cables between the L, R AUDIO INPUT jacks on the TV and the AUDIO OUT jacks on the DVD player.

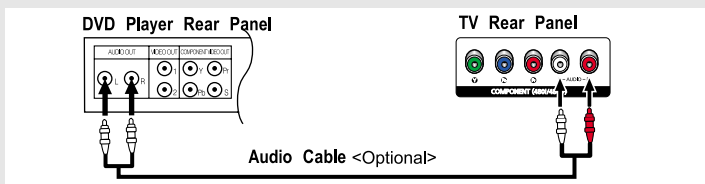

2

Connect a video cable between the COMPONENT (Y, Pb, Pr) jacks on the TV and the Y, Pb, Pr jacks on the DVD player.

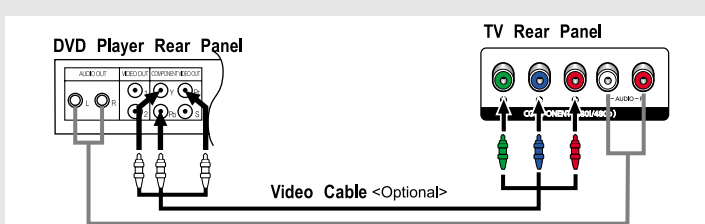

Note: For an explanation of Component video, see your DVD player owner's manual.

* Each external input source device has a different back panel configuration.

Chapter Three

SPECIAL FEATURES

Turning the TV On and Off

Press the **POWER** button.

You can also use the Power button on the front panel.

Changing Channels

Using the Channel Buttons

1

Press the **CH** \wedge / \vee buttons to change channels.

When you press the **CH** \wedge / \vee buttons, the TV changes channels in sequence.

You will see all the channels that the TV has memorized. (The TV must have memorized at least three channels.) You will not see channels that were either erased or not memorized.

Using the PRE-CH Button to select the Previous Channel

1

Press the **PRE-CH** button.

The TV will switch to the last channel viewed.

To quickly switch between two channels that are far apart, tune to one channel, then use the number button to select the second channel. Then use the **PRE-CH** button to quickly alternate between them.

Adjusting the Volume

1 To control speaker volume.



Volume 70

2 To control headphone volume. - when headphone is connected.



Volume 20

When a headphone is connected, the Volume Control OSD screen changes automatically as in number 2.

Press the **VOL +/-** buttons to increase or decrease the volume.

Using Mute

At any time, you can temporarily cut off the sound using the **Mute** button.

1

Press **MUTE** and the sound cuts off.

The word “ Mute” will appear in the lower-left corner of the screen.

2

To turn mute off, press the **MUTE** button again, or simply press the **VOL +/-** buttons.

SPECIAL FEATURES

Viewing the Display

The display identifies the current channel and the status of certain audio-video settings.

1

Press the **INFO** button on the remote control.

The TV will display the channel, the type of sound, and the status of certain picture and sound settings.

Air	3
Mono	
Picture Mode	Dynamic
Sound Mode	Standard
MTS	Stereo
Caption	On
Clock	12:00 pm

- ◀ The on-screen displays disappear after about ten seconds.
- ◀ Press the button once more or wait approximately 10 seconds and it disappears automatically.
- ◀ Allows the user to adjust the settings according to his/her preference and shows the current settings.

Viewing the Menus

1

With the power on, press the **MENU** button.

The main menu appears on the screen. It's left side has five icons: Input, Picture, Sound, Channel, and Setup.

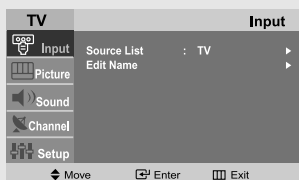

- ◀ The on-screen menus disappear from the screen after about two minutes.

2

Use the **UP/DOWN ▲▼** buttons to select one of the five icons. Then press **ENTER** to access the icon's sub-menu.

3

Press the **EXIT** button to exit.

- ◀ You can also use the **SOURCE** buttons on the control panel of the TV to make selections.

Chapter Four

OPERATION

Plug & Play Feature

When the TV is initially powered On, two basic customer settings proceed automatically and subsequently: Setting Auto program, Clock.

1

Press the **POWER** button on the remote control.

The message "Plug & Play" is displayed.





Plug & Play

2

Press the **UP/DOWN▲▼** buttons to select "English", "Français", "Español", or "Português" then press the **ENTER**  button. Press the **UP/DOWN▲▼** buttons to select "Air", "STD", "HRC" or "IRC", then press the **ENTER**  button.



Language

English
Français
Español
Português

◀ Move  Enter  Stop

Air/CATV

Air
STD
HRC
IRC

◀ Move  Enter  Stop

3

Press the **ENTER**  Button. The TV will begin memorizing all of the available channels.

Press the **ENTER**  button to stop.

Auto Program

Check antenna input.



Start Exit

◀ Move  Enter  Clock

Auto Program

Air 3

Stop Exit

◀ Move  Enter  Clock

4

Press the **LEFT/RIGHT◀▶** buttons to move to the hour or minute. Set the hour or minute by pressing the **UP/DOWN▲▼** buttons. (refer to "Setting the Clock" on page 29).

Clock

Hour Minute am/pm
12 00 am

◀ Move  Adjust  Stop

5

The message "Enjoy your watching." is displayed.

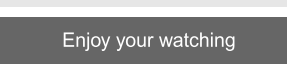

Enjoy your watching

OPERATION

Memorizing the Channels

Your TV can memorize and store all of the available channels for both “off-air” (antenna) and cable channels. After the available channels are memorized, use the CH ^ and CH v buttons to scan through the channels. This eliminates the need to change channels by entering the channel digits. There are three steps for memorizing channels: selecting a broadcast source, memorizing the channels (automatic) and adding and deleting channels (manual).

Selecting the Video Signal-source

Before your television can begin memorizing the available channels, you must specify the type of signal source that is connected to the TV (i.e., an antenna or a cable system).

1

Press the **MENU** button to display the menu.

Press the **UP/DOWN ▲▼** buttons to select “Channel”, then press the **ENTER** button.

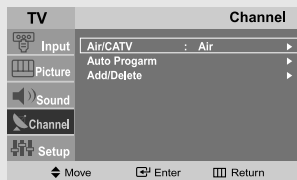

2

Repeatedly press the **ENTER** button to cycle through these choices: Air, STD, HRC or IRC (all cable TV).

Press the **UP/DOWN ▲▼** buttons to select the Video signal source, then press the **ENTER** button.

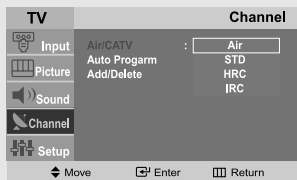

Note : STD, HRC and IRC identify various types of cable TV systems. Contact your local cable company to identify the type of cable system that exists in your particular area.

At this point, the signal source has been selected.
Proceed to “Storing Channels in Memory” (next page).

OPERATION

Storing Channels in Memory (Automatic Method)

1

First, select the correct signal source (Air, STD, HRC, IRC). See steps 1~2 on previous page.

Press the **MENU** button.

Press the **UP/DOWN ▲▼** buttons to select "Channel", then press the **ENTER**  button.

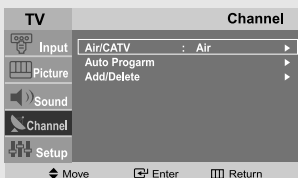

2

Press the **UP/DOWN ▲▼** buttons to select "Auto Program". Press the **ENTER**  button.

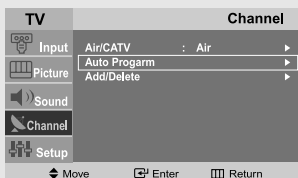

3

Press the **ENTER**  button. The TV will begin memorizing all of the available channels.

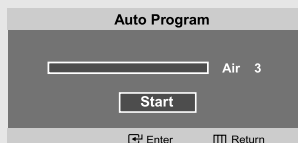

4

After all the available channels are stored, the Auto Program menu reappears. Press the **EXIT** button to exit.

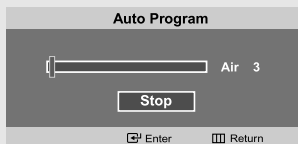

◀ The TV automatically cycles through all of the available channels and stores them in memory. This takes about one to two minutes.



Press **ENTER**  at any time to interrupt the memorization process and return to the CHANNEL menu.

To check the channels stored in memory

Press the **CH ▲/▼** button.

- Only the channels stored in memory are selected.

To select channels over 100

Ex) Press  \rightarrow  \rightarrow  to select channel 108.

OPERATION

ADD and DEL Channels (Manual Method)

1

Use the number buttons to directly select the channel to Add or Delete.

Press the **MENU** button to display the menu.

Press the **UP/DOWN▲▼** buttons to select "Channel", then press the **ENTER** button.

Press the **UP/DOWN▲▼** buttons to select "Add/Delete". Press the **ENTER** button.

Press the **ENTER** button to select "Add" or "Delete".

Press the **EXIT** button.

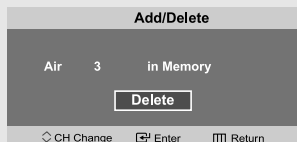
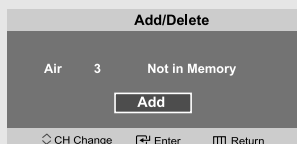
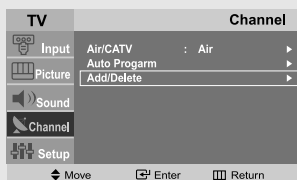

2(Alternate method)

Press the **ADD/DEL** button.

Repeatedly pressing **ENTER** will alternate between "Add" and "Delete".

Press the **EXIT** button.

You can view any channel (including an erased channel) by using the number buttons on the remote control.

OPERATION

To select the Input Source

Use to select TV or other external input sources connected to the TV.

Use to select the screen of your choice.

1

Press the **MENU** button to display the on-screen menu.

Press the **ENTER** button.

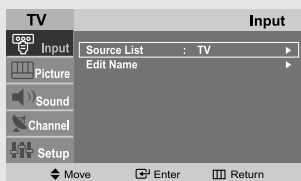

2

Press the **ENTER** button to select "TV", then press the **ENTER** button.

3

Press the **UP/DOWN** buttons to select the Input source, then press **ENTER**.

Press Source button in remote control to operate.

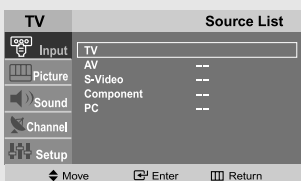

Note: You can also press the SOURCE button on the remote to choose the Input source.

OPERATION

To Edit the Input Source Name

Name the input device connected to the input jacks to make your input source selection easier.

1

Press the **MENU** button to display the menu.

Press the **ENTER** button.

Press the **UP/DOWN** buttons to select "Edit Name" then press the **ENTER** button.

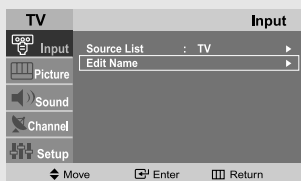

2

Press the **UP/DOWN** buttons to select "AV", "S-Video", "Component", or "PC" then press the **ENTER** button.

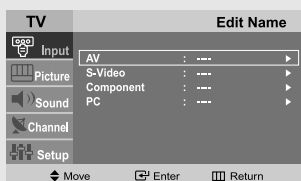

3

Press the **UP/DOWN** buttons repeatedly until the appropriate source name appears.

After the source is selected, press the **ENTER** button.

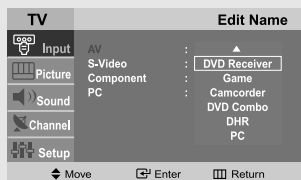
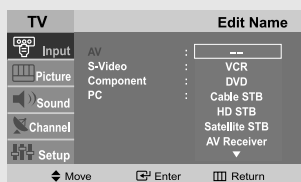

Note: DHR = DVD HDD Receiver

OPERATION

Using Automatic Picture Settings

Your TV has four automatic picture settings (“Dynamic”, “Standard”, “Movie”, and “Custom”) that are preset at the factory. You can activate either Dynamic, Standard, or Movie by pressing P.MODE (or by making a selection from the menu). Or, you can select “Custom” which automatically recalls your personalized picture settings.

1

Press the **MENU** button to display the menu.

Press the **UP/DOWN ▲▼** buttons to select “Picture”, then press the **ENTER**  button twice.

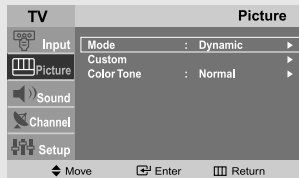

2

Press the **UP/DOWN ▲▼** buttons to select the “Dynamic”, “Standard”, “Movie”, or “Custom” picture setting.

Press the **EXIT** button to exit.

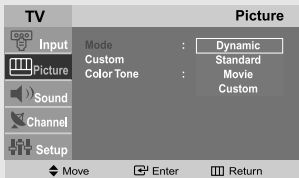

Alternate method:

Simply press the **P.MODE** button on the remote control to select one of the standard picture settings.

- Choose *Dynamic* to increase the clarity and sharpness of the picture.
- Choose *Standard* for the standard factory settings.
- Choose *Movie* when viewing a Movie.
- Choose *Custom* if you want to adjust the settings according to personal preference (see “Customizing the Picture”, page 22).

OPERATION

Customizing the Picture

You can use the on-screen menus to change the contrast, brightness, sharpness, color and tint according to personal preference.
(Alternatively, you can use one of the “automatic” settings. See the previous page.)

1

Press the **MENU** button to display the menu.

Press the **UP/DOWN ▲▼** buttons to select “Picture”, then press the **ENTER**  button.

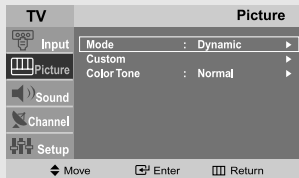

2

Press the **UP/DOWN ▲▼** buttons to select “Custom”, then press the **ENTER**  button.

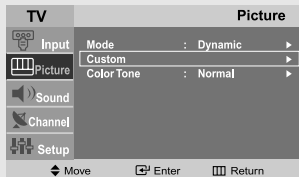

3

Press the **ENTER**  button to select a particular item.

Press the **UP/DOWN ▲▼** buttons to select Contrast, Brightness, Sharpness, Color, or Tint.

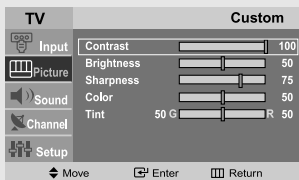

4

Press the **LEFT/RIGHT ◀▶** buttons to decrease or increase the value of a particular item.
For example, if you select “Contrast”, pressing **RIGHT ▶** increases it.

Press the **EXIT** button to exit.



Note: The Tint feature does not work in component mode.

OPERATION

Using Automatic Sound Settings

Your TV has two automatic sound settings (“Standard”, and “Speech”) that are preset at the factory. You can activate either of them by pressing the S.MODE button (or by making a selection from the on-screen menu). Or, you can select “Custom Sound”, which automatically recalls your personalized sound settings.

1

Press the **MENU** button to display the menu.

Press the **ENTER** button to select “Sound”, then press the **ENTER** button.

Press the **ENTER** button to select “Mode”, then press the **ENTER** button.

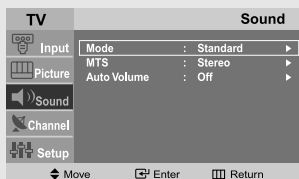

2

Press the **UP/DOWN** buttons repeatedly to select the “Standard”, or “Speech” sound settings.

Press the **EXIT** button to exit.

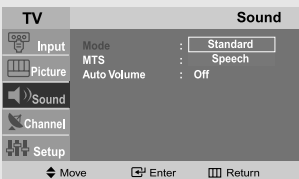

Alternate method:

Simply press the **S.MODE** button on the remote control to select one of the standard sound settings.

- Choose *Standard* for the standard factory settings.
- Choose *Speech* when watching a show that is mostly dialogue (i.e., news).

OPERATION

To select the Sound option

The sound settings can be adjusted to suit your personal preference. (Alternatively, you can use one of the “automatic” settings. See the previous page.) Depending on the particular program being broadcast, you can listen to stereo, mono, or a Separate Audio Program. (SAP audio is usually a foreign-language translation. Sometimes SAP has unrelated information like news or weather.)

1

Press the **MENU** button to display the menu.

Press the **UP/DOWN ▲▼** buttons to select “Sound”, then press the **ENTER** button.

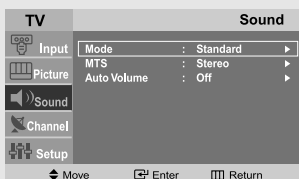

2

Press the **UP/DOWN ▲▼** buttons to select “MTS”, then press the **ENTER** button.

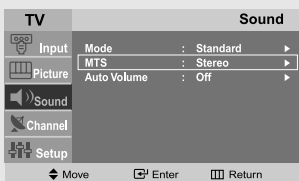

3

Press the **UP/DOWN ▲▼** buttons to select “Mono”, “Stereo” or “SAP”, then press the **ENTER** button. Press the **EXIT** button to exit.

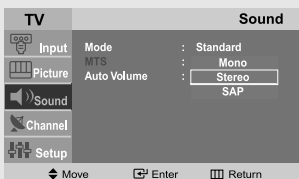

- Choose *Mono* for channels that are broadcasting in mono, or if you are having difficulty receiving a stereo signal.
- Choose *Stereo* for channels that are broadcasting in stereo.
- Choose *SAP* to listen to the Separate Audio Program, which is usually a foreign-language translation.

You can also change the MTS setting by pressing the “MTS” button on the remote control. (When you change channels, MTS is set to “Stereo” automatically. To listen in ‘SAP’ or ‘Mono’, change the MTS setting.)

OPERATION

Selecting a Menu Language

1

Press the **MENU** button to display the menu.

Press the **UP/DOWN ▲▼** buttons to select "Setup", then press the **ENTER**  button.

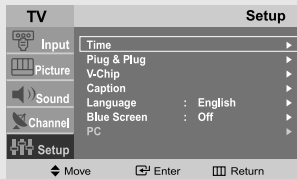

2

Press the **UP/DOWN ▲▼** buttons to select Language.

Press the **ENTER**  button.

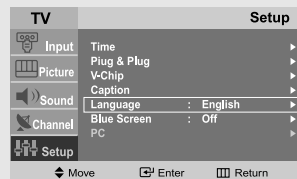

3

Press the **UP/DOWN ▲▼** buttons to select "English", "Français", "Español", or "Português".

Press the **EXIT** button to exit.

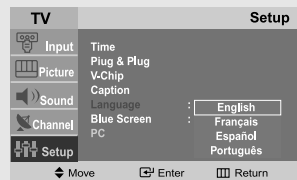

OPERATION

Setting the Blue Screen Mode

If no signal is being received or the signal is very weak, a blue screen automatically replaces the noisy picture background.

If you wish to continue viewing the poor picture, you must set the “Blue screen” mode to “Off”.

1

Press the **MENU** button to display the menu.

Press the **UP/DOWN ▲▼** buttons to select “Setup”, then press the **ENTER**  button.

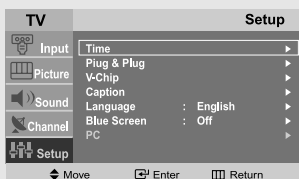

2

Press the **UP/DOWN ▲▼** buttons to select “Blue Screen”, then press the **ENTER**  button.

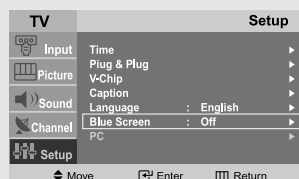

3

Press the **UP/DOWN ▲▼** buttons to set Blue Screen “On” or “Off”.

Press the **EXIT** button to exit.

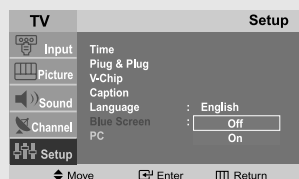

◀ Pressing the **UP/DOWN ▲▼** buttons will alternate between “On” and “Off”.

OPERATION

Adjusting the Color Tone

You can change the color of the entire screen according to your preference.

1

Press the **MENU** button to display the menu.

Press the **UP/DOWN ▲▼** buttons to select "Picture", then press the **ENTER** button.

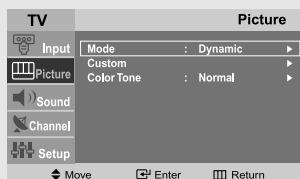

2

Press the **UP/DOWN ▲▼** buttons to select "Color Tone", then press the **ENTER** button.

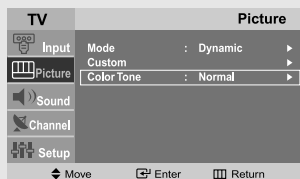

3

Press the **UP/DOWN ▲▼** buttons to select Color Tone.

Press the **EXIT** button to exit.

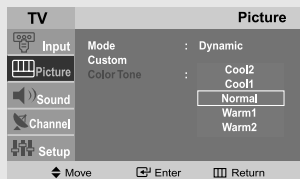

◀ Choose from the following Color Tone settings: "Cool 2", "Cool 1", "Normal", "Warm 1", "Warm 2" according to personal preference.

OPERATION

Automatic Volume Control

Reduces the differences in volume level among broadcasters.

1

Press the **MENU** button to display the menu.

Press the **UP/DOWN ▲▼** buttons to select "Sound", then press the **ENTER**  button.

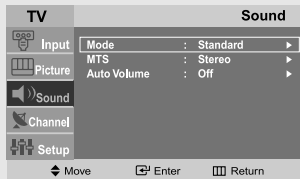

2

Press the **UP/DOWN ▲▼** buttons to select "Auto Volume", then press the **ENTER**  button.

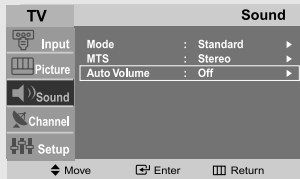

3

Press the **UP/DOWN ▲▼** buttons to set Auto Volume "Off" or "On".

Press the **EXIT** button to exit.

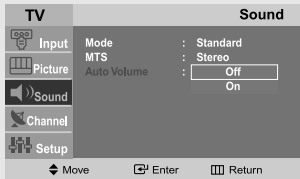

OPERATION

Setting the Clock

Setting the clock is necessary in order to use the various timer features of the TV. Also, you can check the time while watching the TV. (Just press the INFO button.)

Option 1: Setting the Clock Manually

1

Press the **MENU** button to display the on-screen menu.

Press the **UP/DOWN ▲▼** buttons to select "Setup", then press the **ENTER**  button.

Press the **ENTER**  button to select "Time".

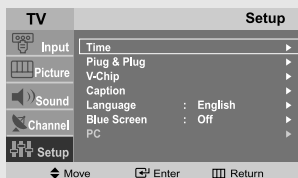

2

Press the **ENTER**  button to select "Clock".

Press the **UP/DOWN ▲▼** buttons to select "Clock Set" then press the **ENTER**  button.

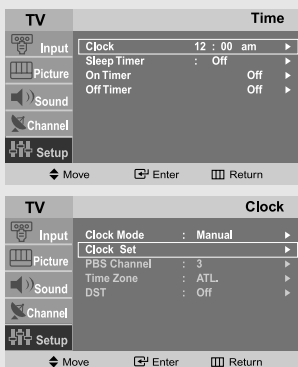

3

Press the **UP/DOWN ▲▼** buttons repeatedly until the correct hour appears.

After the hour is entered, press the **LEFT/RIGHT ◀▶** buttons to select "Minute".

Press the **UP/DOWN ▲▼** buttons until the correct minute appears. Press the **LEFT/RIGHT ◀▶** buttons to select am/pm and adjust with the **UP/DOWN ▲▼** buttons.

Press the **EXIT** button to exit.

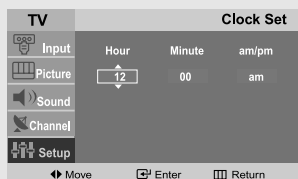

◀ Note : You can also set the time using the numeric buttons on the remote.

OPERATION

Option 2: Using the Local PBS Channel to Automatically Set the TV Clock

1

Press the **MENU** button to display the on-screen menu.

Press the **UP/DOWN ▲▼** buttons to select "Setup", then press the **ENTER** button.

Press the **ENTER** button to select "Time".

Press the **ENTER** button to select "Clock".



2

Press the **UP/DOWN ▲▼** buttons to select "Clock Mode" then press the **ENTER** button.

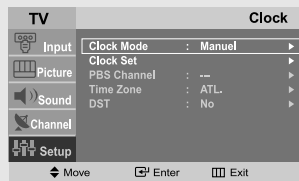

3

Press the **UP/DOWN ▲▼** buttons to select "Auto" then press the **ENTER** button.

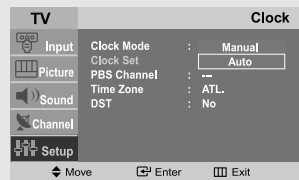

4

Press the **UP/DOWN ▲▼** buttons to select "PBS Channel" then press the **ENTER** button.

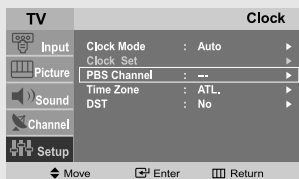

5

Press the **UP/DOWN ▲▼** buttons to select your local PBS channel.

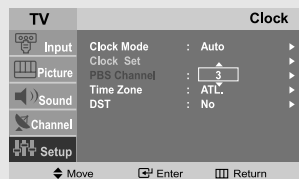

OPERATION

6

Press the **UP/DOWN ▲▼** buttons to select "Time Zone" then press the **ENTER**  button.

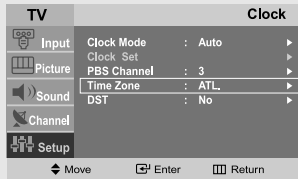

7

Press the **UP/DOWN ▲▼** buttons to change Time Zone.

Sequence: ATL., EAST, CEN, MTN, PAC., ALAS, HAW..

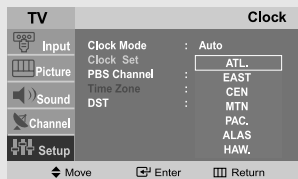

8

Press the **UP/DOWN ▲▼** buttons to select "DST" (Daylight Saving Time) then press the **ENTER**  button.

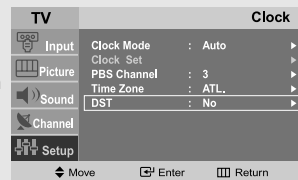

9

Press the **UP/DOWN ▲▼** buttons to select "No" or "Yes" then press the **ENTER**  button.

Press the **EXIT** button to exit.

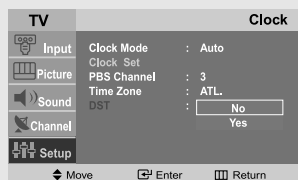

Note: Make sure the PBS channel is in memory before using this feature.

OPERATION

Setting the On/Off Timer

1

Press the **MENU** button to display the on-screen menu.

Press the **UP/DOWN ▲▼** buttons to select "Setup", then press the **ENTER**  button.

Press the **ENTER**  button to select "Time".

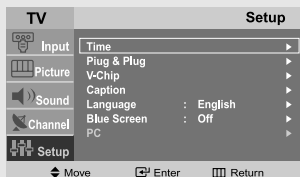

◀ Before using the timer, you must set the TV's clock.
(See "Setting the Clock" on page 29)

2

Press the **UP/DOWN ▲▼** buttons to select "On Timer", then press the **ENTER**  button.

Press the **UP/DOWN ▲▼** buttons repeatedly to select the appropriate hour.

Press the **LEFT/RIGHT ◀▶** buttons repeatedly to select the appropriate minute (i.e., the time when the TV will turn on).

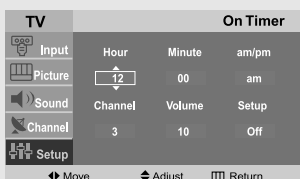
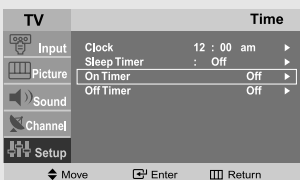

◀ When you set the hours, make sure the correct time of day (am or pm) appears to the right of the time.

OPERATION

3

Press the **LEFT/RIGHT** ◀▶ buttons to select Setup.

Press the **UP/DOWN** ▲▼ buttons to set the "On".
(Repeatedly pressing the **UP/DOWN** ▲▼ buttons will alternate between On and Off.)

When finished, press the **ENTER** ⏎ button.

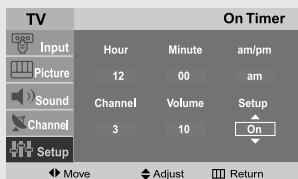

◀ To deactivate the "On time," select "Off" during this step.

4

To set the Off time, press the **UP/DOWN** ▲▼ buttons to select "Off Timer".

Press the **ENTER** ⏎ button and set the hours and minutes. (Follow the same procedure as in steps 2~3 above.)

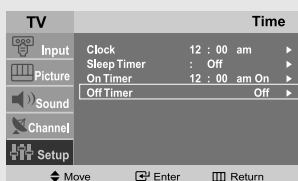

5

When finished setting the timer, press the **EXIT** button to exit.

• Auto Power Off

When you set the timer on, your television will be turned off if you do not operate any controls for 3 hours after the TV has been turned on with the "Timer On" function.

OPERATION

Setting the Sleep Timer

Set the timer for the TV to turn off at the preset time automatically.

Sleep timer

1

Press the **MENU** button to display the on-screen menu.

Press the **UP/DOWN ▲▼** buttons to select "Setup", then press the **ENTER**  button.

Press the **ENTER**  button to select "Time".

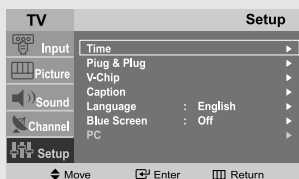

2

Press the **UP/DOWN ▲▼** buttons to select "Sleep Timer", then press the **ENTER**  button.

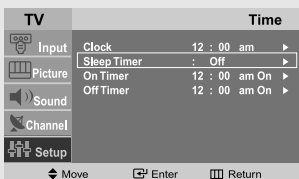

3

Press the **UP/DOWN ▲▼** buttons repeatedly until the correct time appears.

Press the **EXIT** button to exit.



- **Easy Way to Set the Sleep Timer**

Press the  button on the remote.

The number on the screen changes from Off • 30 • 60 • 90 • 120 • 150 • 180

OPERATION

Viewing Closed Captions

Your TV decodes and displays the closed captions that are broadcast with certain TV shows. These captions are usually subtitles for the hearing impaired or foreign-language translations. All VCRs record the closed caption signal from television programs, so home-recorded video tapes also provide closed captions. Most pre-recorded commercial video tapes provide closed captions as well. Check for the closed caption symbol in your television schedule and on the tape's packaging : **CC**.

1

Press the **MENU** button to display the on-screen menu.

Press the **UP/DOWN ▲▼** buttons to select "Setup", then press the **ENTER** **↵** button.

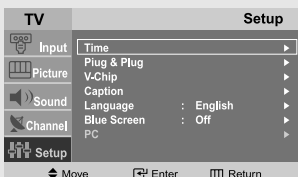

2

Press the **UP/DOWN ▲▼** buttons to select "Caption", then press the **ENTER** **↵** button.

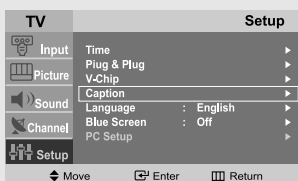

3

Press the **ENTER** **↵** button to select "Caption".

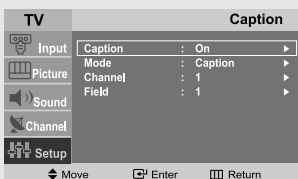

4

Press the **UP/DOWN ▲▼** buttons to set caption "Off" or "On", then press the **ENTER** **↵** button.

Press the **EXIT** button to exit.

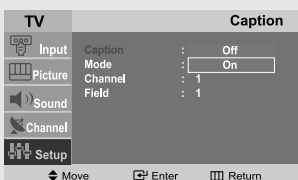

5

Depending on the particular broadcast, it might be necessary to make changes to "Channel" and "Field".

Press the **EXIT** button to exit.

◀ Different channels and fields display different information: Field 2 carries additional information that supplements the information in Field 1. (For example, Channel 1 may have subtitles in English, while Channel 2 has subtitles in Spanish.)

OPERATION

Using the V-Chip

The V-Chip feature automatically locks out programming that is deemed inappropriate for children. The user must first enter a PIN (personal ID number) before any of the V-Chip restrictions can be set up or changed.

Setting Up Your Personal ID Number (PIN)

1

Press the **MENU** button to display the menu.

Press the **UP/DOWN ▲▼** buttons to select "Setup", then press the **ENTER** button.

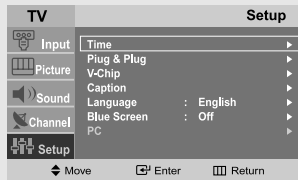

2

Press the **UP/DOWN ▲▼** buttons to select "V-Chip", then press the **ENTER** button.

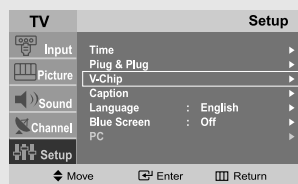

3

The "Enter PIN" screen will appear. Enter your 4-digit PIN.

Note: The default PIN for your new TV set is "0-0-0-0".

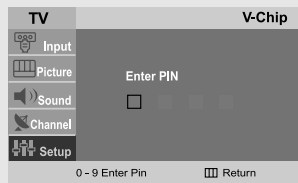

4

After entering a valid PIN number, the "V-Chip" screen will appear. Press the **UP/DOWN ▲▼** buttons to select "Change PIN".

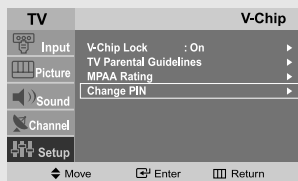

5

Press the **ENTER** button.

The Change PIN screen will appear. Choose any 4-digits for your PIN and enter them.

As soon as the 4 digits are entered, the "Confirm new PIN" screen appears. Re-enter the same 4 digits.

When the Confirm screen disappears, your PIN has been memorized. Press the **EXIT** button to exit.

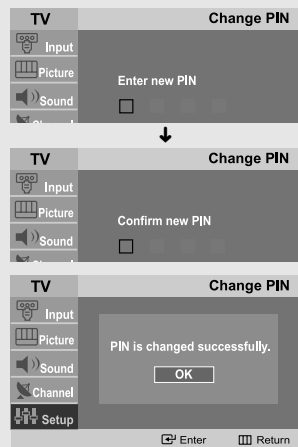

◀ Note: If you forget the PIN, press the remote-control buttons in the following sequence, which resets the PIN to 0-0-0-0:
POWER OFF → MUTE → 8 → 2 → 4 → POWER ON.

OPERATION

How to Enable/Disable the V-Chip

1

Press the **MENU** button to display the menu.

Press the **UP/DOWN ▲▼** buttons to select "Setup", then press the **ENTER**  button.

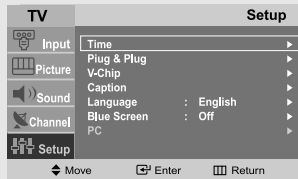

2

Press the **UP/DOWN ▲▼** buttons to select "V-Chip", then press the **ENTER**  button.

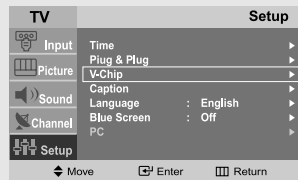

3

The "Enter PIN" screen will appear. Enter your 4-digit PIN.

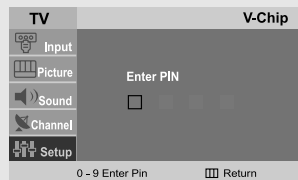

4

The "V-Chip" screen will appear, and "V-Chip Lock" will be selected.

To enable the V-Chip feature, press the **ENTER**  button so that the "V-Chip Lock" is set to Yes. (Pressing the **UP/DOWN ▲▼** buttons will alternate between On and Off.)

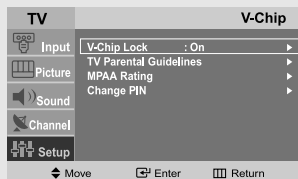

OPERATION

How to Set up Restrictions Using the ‘TV guidelines’

First, set up a personal identification number (PIN), and enable the V-Chip. (See previous section.) Parental restrictions can be set up using either of two methods: The TV guidelines or the MPAA rating.

1

Press the **MENU** button to display the menu.

Press the **UP/DOWN ▲▼** buttons to select “Setup”, then press the **ENTER** button.

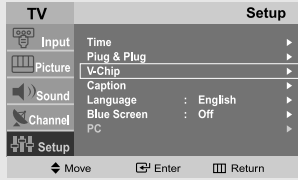

2

Press the **UP/DOWN ▲▼** buttons to select “V-Chip”, then press the **ENTER** button.

The “Enter PIN” screen will appear. Enter your 4-digit PIN.

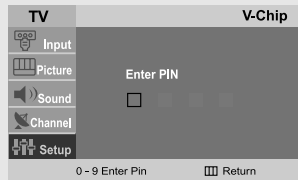

3

Press the **UP/DOWN ▲▼** buttons to select “TV Parental Guidelines”, then press the **ENTER** button.

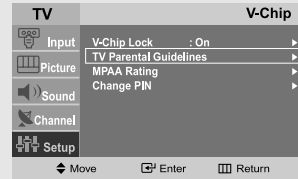

4

The “TV Parental Guidelines” screen will appear. Press the **UP/DOWN ▲▼** buttons to select one of the six age-based categories:

- TV-Y Young children
- TV-Y7 Children 7 and over
- TV-G General audience
- TV-PG Parental guidance
- TV-14 Viewers 14 and over
- TV-MA Mature audience

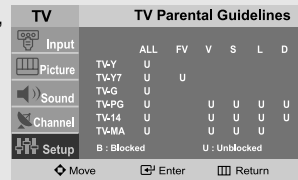



◀ Note: These categories consist of two separate groups : TV-Y and TV-Y7 (young children through age 7), and TV-G through TV-MA (everybody else). The restrictions for these two groups work independently: If a household includes very young children as well as young adults, the TV guidelines must be set up separately for each age group. (See next step.)

OPERATION

5

At this point, one of the TV-Ratings is selected.

Press the **ENTER**() button: Depending on your existing setup, the color of the letter "U" or "B" will be highlighted. (U= Unblocked, B= Blocked)

When the color of the "U" or "B" is highlighted, press the **ENTER**() button to block or unblock the category.

A TV-Rating will be highlighted. To exit this screen, press **MENU** again. To select a different TV-Rating, press the **UP/DOWN**  buttons and then repeat the process.

Note 1: The TV-Y7, TV-PG, TV-14 and TV-MA have additional options.
See the next step to change any of the following sub-ratings:

FV: Fantasy Violence
D: Sexual suggestive Dialog
L: Adult Language
S: Sexual situation
V: Violence

Note 2: The V-Chip will automatically block certain categories that are "more restrictive." For example, if you block "TV-Y" category, then TV-Y7 will automatically be blocked. Similarly, if you block the TV-G category, then all the categories in the "young adult" group will be blocked (TV-G, TV-PG, TV-14 and TV-MA). The sub-ratings (D, L, S, V) work together similarly. (See next section.)

6

How to set the FV, D, L, S and V sub-ratings.

First, highlight one of these TV-Ratings: TV-Y7, TV-PG, TV-14 or TV-MA
(See Step 4, on previous page).

Next, while the TV-Rating is selected, repeatedly press the **ENTER**() button.
This will cycle through the available sub-ratings (FV,L, S, D or V).

A highlighted letter ("U" or "B") will be displayed for each sub-rating. While the "U" or "B" is highlighted, press the **ENTER**() buttons to change the sub-rating.

Press **MENU** once to save the TV guidelines. A TV-Rating will be selected, and no letters "U" or "B" will be changed to yellow.

To exit this screen, press the **MENU** button again. To select a different TV-Rating, press the **UP/DOWN**  buttons and then repeat the process.

Note: The V-chip will automatically block certain categories that are "More restrictive".
For example, if you block the "L" sub-rating in TV-PG, then the "L" sub-ratings in TV-14 and TV-MA will automatically be blocked.

7

Press the **EXIT** button to clear all the screens.

(Or proceed to the next section, and set up additional restrictions based on the MPAA codes).

How to Set up Restrictions Using the MPAA Ratings: G, PG, PG-13, R, NC-17, X

The MPAA rating system uses the Motion Picture Association of America (MPAA) system, and its main application is for movies.

When the V-Chip lock is on, the TV will automatically block any programs that are coded with objectionable ratings (either MPAA or TV-Ratings).

1

Press the **MENU** button to display the menu.

Press the **UP/DOWN ▲▼** buttons to select "Setup", then press the **ENTER**  button.

Press the **UP/DOWN ▲▼** buttons to select "V-Chip", then press the **ENTER**  button.

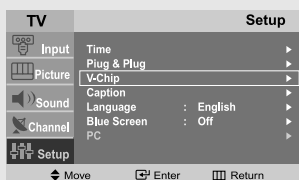

2

The "Enter PIN" screen will appear. Enter your 4-digit PIN.

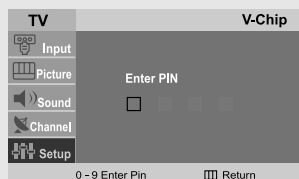

3

Press the **UP/DOWN ▲▼** buttons to select "MPAA Rating", then press the **ENTER**  button.

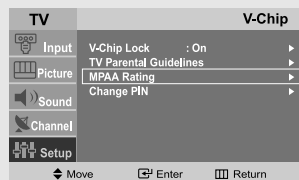

4

Repeatedly press the **UP/DOWN ▲▼** buttons to select a particular MPA rating category. (When a category is selected, its color changes to yellow.)

Pressing the **UP/DOWN ▲▼** buttons will cycle through the MPA categories:

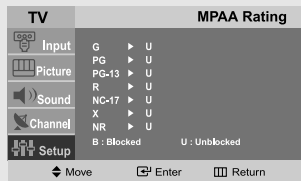

G	General audience (no restrictions).
PG	Parental guidance suggested.
PG-13	PG-13 (Parents strongly cautioned).
R	R (Restricted. Children under 17 should be accompanied by an adult).
NC-17	No children under age 17.
X	X (Adults only).
NR	Not rated.

Press the **UP/DOWN ▲▼** buttons to select a category.

Press the **ENTER(⏏)** buttons to select “U” or “B”.

Press the **EXIT** button to save the settings and to clear all screens.

Note: The V-Chip will automatically block any category that is “more restrictive”. For example, if you block the “PG-13” category, then “R,” “NC-17,” and “X” will automatically be blocked also.

How to Reset the TV after the V-Chip Blocks a Channel (‘Emergency Escape’)

If the TV is tuned to a restricted channel, the V-Chip will block it. The screen will go blank and the following message will appear: “Excessive rating”.

To resume normal viewing, tune to a different channel using the number buttons. Under certain conditions (depending on the rating of the local TV programs) the V-Chip might lock out all the channels.

In this case, use the Menu button for an “emergency escape”:

Select the V-Chip on the Menu. Enter your PIN number, and press the **ENTER(⏏)** button to temporarily disable the V-Chip Lock.

Chapter Five

PC DISPLAY

Using Your TV as a Computer (PC) Display

How to Set up Your PC Software (Windows only)

The Windows display-settings for a typical computer are shown below. However, the actual screens on your PC will probably look different, depending upon your particular version of Windows and your particular video card. Even if your actual screens look different, the same, basic set-up information will apply in most cases. (If not, contact your computer manufacturer or Samsung Dealer.)

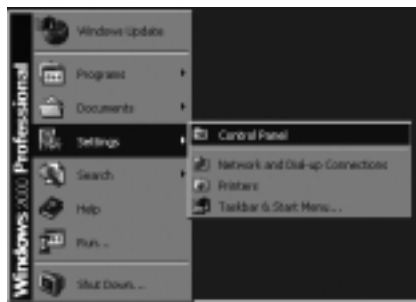

First, click on "Settings" on the Windows start menu.

While "Settings" is highlighted, move the cursor so that "Control Panel" is highlighted.

When the control panel screen appears, click on "Display" and a display dialog-box will appear.

Navigate to the "settings" tab on the display dialog-box.

The two key variables that apply to the TV-PC interface are "resolution" and "colors." The correct settings for these two variables are:

- * Size (sometimes called "resolution"):
- 15" 1024 x 768 pixels
- 17" 1280 x 1024 pixels
- 20" 640 x 480 pixels

If a vertical-frequency option exists on your display settings dialog box, the correct value is "60" or "60 Hz". Otherwise, just click "OK" and exit the dialog box.

PC DISPLAY

Adjusting the Screen Quality

The purpose of the picture quality adjustment is to remove or reduce picture noise. If the noise is not removed by fine tuning alone, then do the frequency adjustments to the utmost and fine tune again. After the noise has been reduced, re-adjust the picture so that it is aligned to the center of the screen.

1

Press the **MENU** button to display the menu.

Press the **UP/DOWN ▲▼** buttons to select "Setup", then press the **ENTER** button.

Press the **UP/DOWN ▲▼** buttons to select "PC", then press the **ENTER** button.

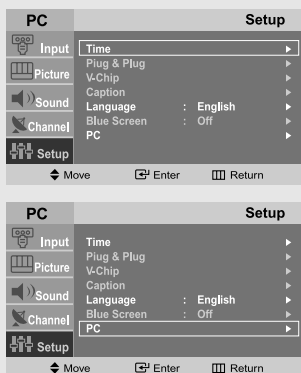

2

Press the **ENTER** button to select "Image Lock".



3

Press the **UP/DOWN ▲▼** buttons to select "Coarse" or "Fine", then press the **ENTER** button.

Press the **LEFT/RIGHT ◀▶** buttons to adjust the screen quality, vertical stripes may appear or the picture may be blurry.

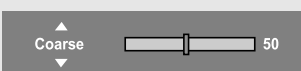
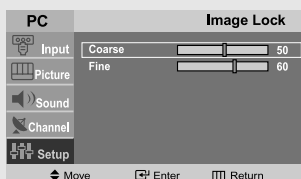

< Adjusting Coarse >

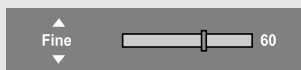

< Adjusting Fine >

4

When you are satisfied with the settings, press the **MENU** button repeatedly to return to normal viewing.

PC DISPLAY

Changing the Screen Position

1

Press the **MENU** button to display the menu.

Press the **UP/DOWN ▲▼** buttons to select "Setup", then press the **ENTER**  button.

Press the **UP/DOWN ▲▼** buttons to select "PC", then press the **ENTER**  button.

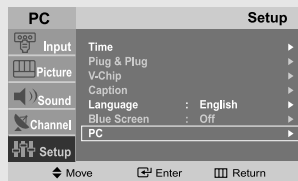
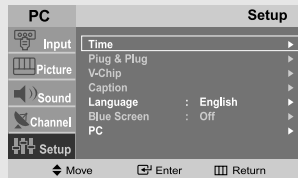

2

Press the **UP/DOWN ▲▼** buttons to select "Position", then press the **ENTER**  button.

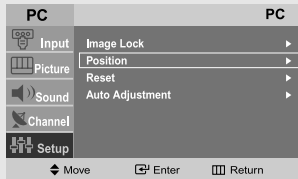

3

Press the **UP/DOWN ▲▼** buttons to adjusting the V-Position.

Press the **LEFT/RIGHT ◀▶** buttons to adjust the H-Position.

Press the **EXIT** button to exit.

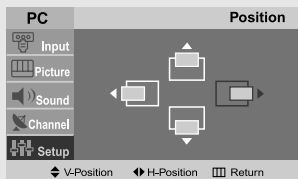



PC DISPLAY

To Initialize the Screen Position or Color Settings

1

Press the **MENU** button to display the menu.

Press the **UP/DOWN ▲▼** buttons to select "Setup", then press the **ENTER**  button.

Press the **UP/DOWN ▲▼** buttons to select "PC", then press the **ENTER**  button.

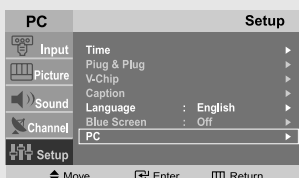
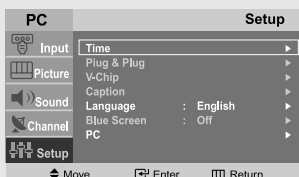

2

Press the **UP/DOWN ▲▼** buttons to select "Reset", then press the **ENTER**  button.



3

Press the **UP/DOWN ▲▼** buttons to select "Image Reset" or "Color Reset", then press the **ENTER**  button.

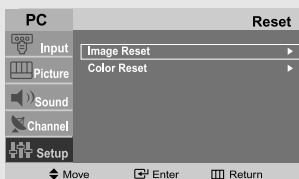

Image reset is completed.

< Image Reset >

Color reset is completed.

< Color Reset >

Press the **EXIT** button to exit.

PC DISPLAY

How to Auto Adjust

Use the Auto Adjust function to have the TV set automatically adjust the video signals the monitor receives. The function also automatically fine-tunes the settings and adjusts the frequency values and positions.

1

Press the **MENU** button to display the menu.

Press the **UP/DOWN ▲▼** buttons to select "Setup", then press the **ENTER** button.

Press the **UP/DOWN ▲▼** buttons to select "PC", then press the **ENTER** button.

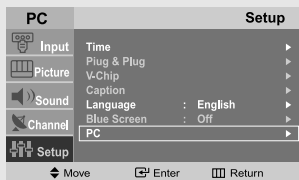
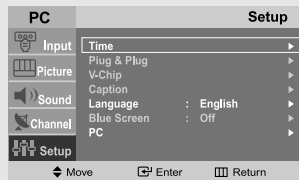

2

Press the **UP/DOWN ▲▼** buttons to select "Auto Adjustment", then press the **ENTER** button.

Press the **EXIT** button to exit.

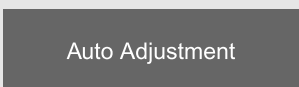
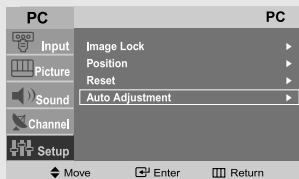

PC DISPLAY

Using Automatic Picture Settings

1

Press the **MENU** button to display the menu.

Press the **UP/DOWN ▲▼** buttons to select "Picture", then press the **ENTER**  button twice.

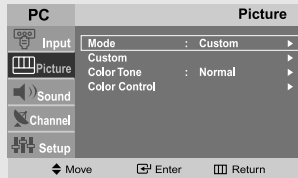

2

Press the **UP/DOWN ▲▼** buttons to select the "Entertain", "Internet", "Text", or "Custom" picture setting.

Press **ENTER**  button. Press the **EXIT** button to exit.

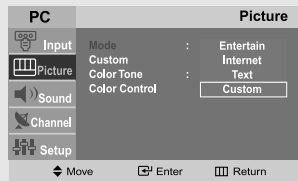

PC DISPLAY

Customizing the Picture

You can use the on-screen menus to change the contrast, brightness, and sharpness according to personal preference.

(Alternatively, you can use one of the “automatic” settings.)

1

Press the **MENU** button to display the menu.

Press the **UP/DOWN ▲▼** buttons to select “Picture”, then press the **ENTER**  button.

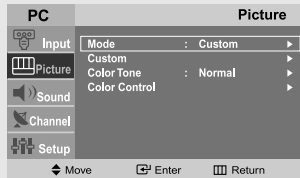

2

Press the **UP/DOWN ▲▼** buttons to select “Custom”, then press the **ENTER**  button.

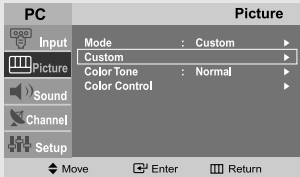

3

Press the **UP/DOWN ▲▼** buttons to select “Contrast” or “Brightness”.

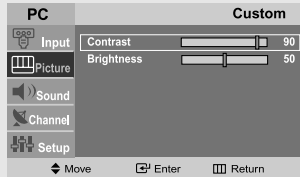

4

Press the **LEFT/RIGHT ◀▶** buttons to decrease or increase the value of a particular item. For example, if you select “Contrast”, pressing **RIGHT ▶** increases it.

Press the **EXIT** button to exit.

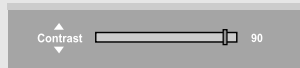

PC DISPLAY

Adjusting the Color Tone

You can change the color of the entire screen according to your preference.

1

Press the **MENU** button to display the menu.

Press the **UP/DOWN ▲▼** buttons to select "Picture", then press the **ENTER**  button.

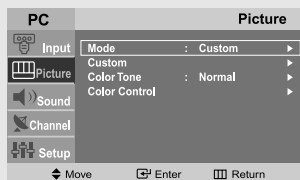

2

Press the **UP/DOWN ▲▼** buttons to select "Color Tone", then press the **ENTER**  button.

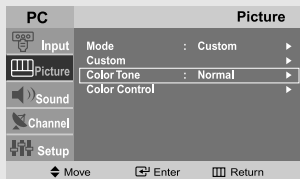

3

Press the **UP/DOWN ▲▼** buttons to select color tone.

Press the **EXIT** button to exit.

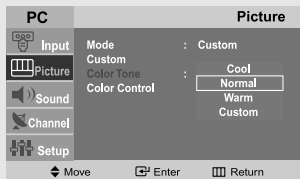

◀ Choose from the following Color Tone settings: "Cool", "Normal", "Warm", "Custom", according to personal preference.

PC DISPLAY

Customizing the color

1

Press the **MENU** button to display the menu.

Press the **UP/DOWN ▲▼** buttons to select "Picture", then press the **ENTER** button.

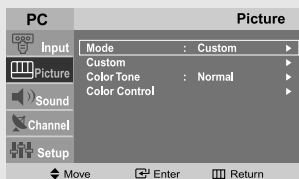

2

Press the **UP/DOWN ▲▼** buttons to select "Color Control", then press the **ENTER** button.

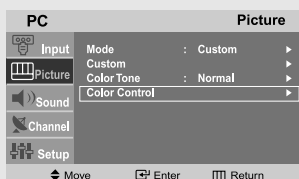

3

Press the **ENTER** button to select a particular item.

Press the **UP/DOWN ▲▼** buttons to select Red, Green, or Blue.

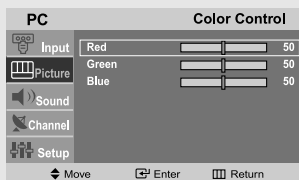

4

Press the **LEFT/RIGHT ◀▶** buttons to decrease or increase the value of a particular item. For example, if you select "Red", pressing **RIGHT ▶** increases it.

Press the **EXIT** button to exit.

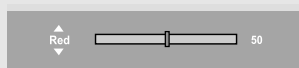

APPENDIX

Using the Anti-Theft Kensington Lock

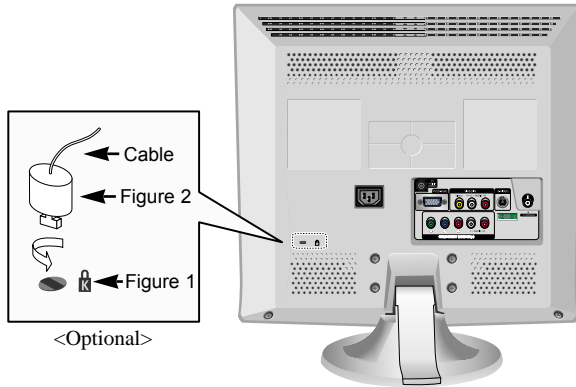

The Kensington lock is a device used to physically fix the system when using it in a public place. The locking device has to be purchased separately. The appearance and locking method may differ from the illustration depending on the manufacturer. Please refer to the manual provided with the Kensington lock for proper use.

1. Insert the locking device into the Kensington slot on the LCD TV (Figure 1), and turn it in the locking direction (Figure 2).
2. Connect the Kensington lock cable.
3. Fix the Kensington lock to a desk or a heavy stationary object.

Retractable Stand

Note: The maximum tilt angle is 13 degrees in the backward direction.

Please do not tilt the TV outside the specified range. Using excessive force to tilt the TV may cause permanent damage to the mechanical part of the stand. The 20" model swivels left and right.



< LT-P1545 / LTP1745 >



< LT-P2045 >

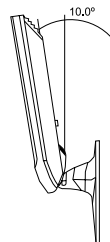
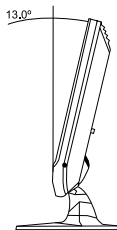

APPENDIX

Installing the Wall Mount Kit

This installation is to be used when attaching the wall mount to a concrete wall. When attaching to other building materials, please contact your nearest dealer.

1 Secure the bracket to the wall.

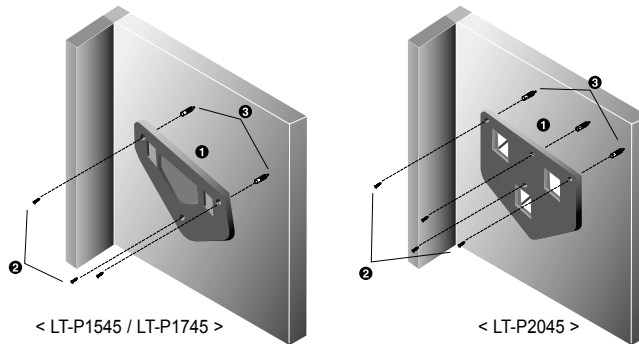

2 Fold the stand in the direction of the arrow. **3** Mount the TV on the wall mount bracket.

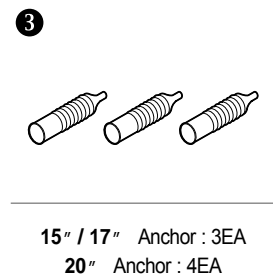
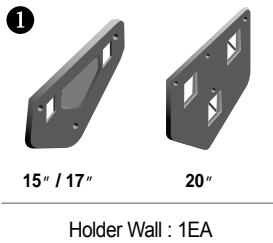
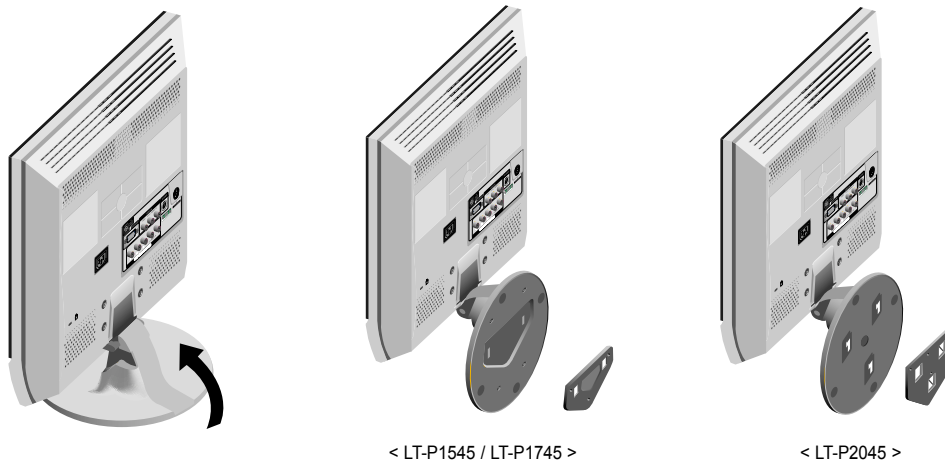

APPENDIX

Installing VESA compliant mounting devices

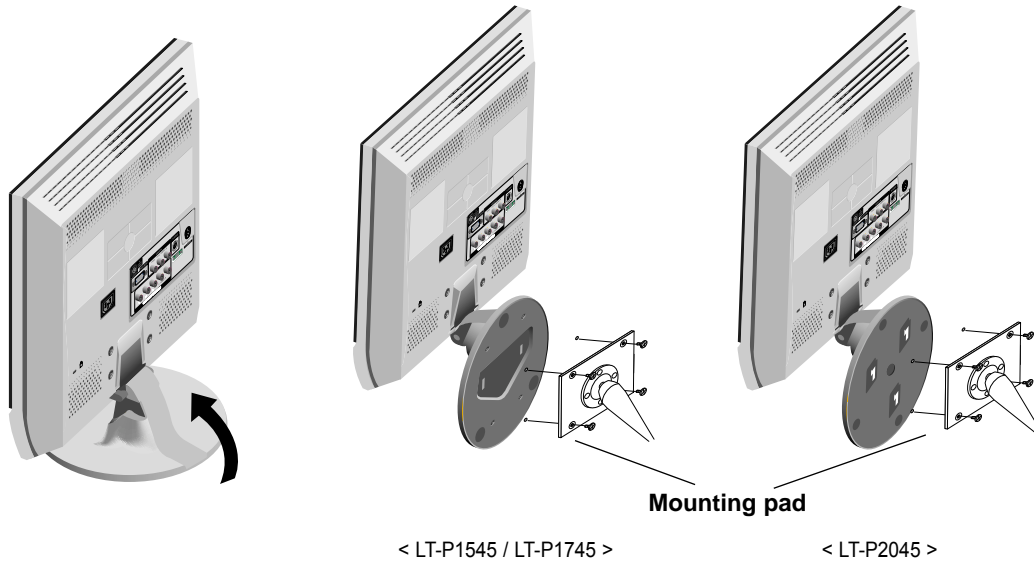

Align the mounting interface pad with the holes in the rear cover mounting pad and secure it with the four screws that come with the arm-type base, wall mount hanger or other bases.

Wall Mount Instructions

The following instructions apply to a hollow sheet-rock wall only. Tools/Hardware needed - Philips screwdriver, four toggle bolts, 5/8in dia. Drill bit and drill. Contact Ergotron at (800) 888-8458 to purchase the triple pivot direct mount adapter and wall mount bracket kit.

- LT-P1545 (15") : No. 47 - 007 - 099 (Pivot direct mount adapter)
No. 97 - 101 - 003 (Wall mount bracket kit)
- LT-P1745 (17") : No. 47 - 007 - 099 (Pivot direct mount adapter)
No. 97 - 101 - 003 (Wall mount bracket kit)
- LT-P2045 (20") : No. 47 - 007 - 099 (Pivot direct mount adapter)
No. 97 - 101 - 003 (Wall mount bracket kit)

Align the wall mount bracket on the wall at the desired height, making sure that the bracket will be mounted between the wall studs. Mark the four corner openings and drill four 5/8-diameter holes. Assemble the wall mount kit according to the instructions provided with it. Securely attach Ergotron's flat panel, triple pivot direct mount adapter to the back of the TV using the four 4mm, .7 pitch x 10mm screws provided with the arm. Secure the assembly to the wall using four 3/16 by 3-inch long toggle bolts.

APPENDIX

Cleaning and Maintaining Your TV

With proper care, your TV unit will give you many years of service. Please follow these guidelines to get the maximum performance from your TV.

Placement

- Do not place the TV near extremely hot, cold, humid or dusty places.
- Do not place the TV near appliances with electric motors that create magnetic fields, such as vacuum cleaners.
- Keep the ventilation openings clear; do not place the TV on a soft surface, such as cloth or paper.
- Place the TV in a vertical position only.

Liquids

- Do not handle liquids near or on the TV.
Liquids that spill into it can cause serious damage.

Cabinet

- Never open the cabinet or touch the parts inside.
- Wipe your TV with a clean, dry cloth. Never use water, cleaning fluids, wax, or chemicals.
- Do not put heavy objects on top of the cabinet.

Temperature

- If your TV is suddenly moved from a cold to a warm place, unplug the power cord, and allow at least two hours for moisture that may have formed inside the unit to dry completely.

Using Your TV in Another Country

If you plan to take your TV with you to a foreign country, please be aware of the different television systems that are in use around the world. A TV designed for one system may not work properly with another system due to differences in the TV channel frequencies.

APPENDIX

Display Mode

If the signal from the system equals the standard signal mode, the screen is adjusted automatically. If the signal from the system doesn't equal the standard signal mode, adjust the mode by referring to your Videocard user guide; otherwise there may be no video. For the display modes listed below, the screen image has been optimized during manufacture.

Preset timing mode

Mode	Resolution	Horizontal Frequency (kHz)	Vertical Frequency (Hz)	Pixel Clock Frequency (MHz)	Sync Polarity (H/V)
VGA LT-P1545, 1745, 2045	720X400	31.469	70.087	28.322	- / +
	640X480	31.469	59.940	25.175	- / -
	640X480	37.500	75.000	31.500	- / -
SVGA LT-P1545, 1745	800X600	46.875	75.000	49.500	+ / +
XGA LT-P1545,1745	1024X768	48.363	60.004	65.000	- / -
	1024X768	60.023	75.029	78.750	+ / +
SXGA LT-P1745	1280X1024	63.981	60.020	108.000	+,- / -,+
	1280X1024	79.976	75.025	135.000	+ / +

APPENDIX

Specifications

Model Name	LT-P1545	LT-P1745	LT-P2045
Panel			
Size	13.05(H) x 10.03(V)inch	15.09(H) x 11.73(V)inch	16.25(H) x 12.24(V)inch
Display Size	11.97(H) x 8.98(V)inch	13.30(H) x 10.64(V)inch	16.06(H) x 12.04(V)inch
Type	a-si TFT active matrix	a-si TFT active matrix	a-si TFT active matrix
Pixel Pitch	0.01169(H) x 0.01169(V)inch	0.01039(H) x 0.01039(V)inch	0.01003(H) x 0.01003(V)inch
Viewing Angle	140/115	120/120	160/150
Frequency			
Horizontal	30 ~ 60kHz	30 ~ 80 kHz	30 ~ 38kHz
Vertical	50 ~ 75Hz	50 ~ 75Hz	50 ~ 75Hz
Display Color	16.2 Million	16.2 Million	16.7 Million
Resolution			
Optimum	1024 x 768@60Hz	1280 x 1024@60Hz	640 x 480@60Hz
Maximum	1024 x 768@75Hz	1280 x 1024@75Hz	640 x 480@75Hz
Input Signal	H/V Separate, TTL, P or N 0.7 Vp-p @75 Ω		
Sync. Video Signal			
Video	NTSC CVBS, S-VHS, RGB		
Color System Video System			
Component			
Video Input	480i, 480p	480i, 480p	480i, 480p
Audio Input	500mVrms	500mVrms	500mVrms
Power Supply	AC 120V ~ 60Hz		
Input Output			
Power Consumption			
Maximum	40W	45W	55W
Power Saving	<3W	<3W	<3W
Dimension (W x D x H)			
TV Body	14.18 x 2.53 x 13.33 inch (360.2 x 64.2 x 338.6 mm)	16.44 x 2.88 x 15.5 inch (417.5 x 73.3 x 393.5 mm)	18.86 x 2.94 x 17.18 inch (479.0 x 74.7 x 436.4 mm)
With stand	14.18 x 7.59 x 15.61 inch (306.2 x 192.9 x 396.5 mm)	16.44 x 7.59 x 16.74 inch (417.5 x 192.9 x 425.3 mm)	18.86 x 8.9 x 18.23 inch (479.0 x 226.0 x 463.0 mm)
Weight			
With stand	3.6kg(7.94lbs)	5.0kg (11.02 lbs)	7.15kg (15.76 lbs)
Environmental Considerations	50°F to 104°F (10°C to 40°C) 10%to 80%, non-condensing -4°F to 113°F (-20°C to 45°C) 5%to 95%, non-condensing		
Operating Temperature			
Operating Humidity			
Storage Temperature			
Storage Humidity			
Audio Characteristics	RCA Jack Red®, White(L), 0.5Vrms(-9dB) 3.5φ Stereo Jack, 0.5Vrms(-9dB) 2.5W x 2 Max.10mW Output(3.5φ Stereo Jack 32) RF : 80Hz ~15kHz at -3dB A/V : 80Hz ~20kHz at -3dB		
Audio Input			
PC Audio Input			
Audio Output			
Headphone Output			
Frequency Response			